

Check the correct float level position as follows:

- for connected floats, hold the carburettor body in the position shown in fig. 13 and check that the float is at the correct distance from the carburettor body face as specified in the table.
- for the floats with independent parts, hold the carburettor upside down (fig. 14) and check that the float arm is parallel to the carburettor face.

Whenever the float or float-arm position does not correspond to the proper specified level setting or is not parallel to the float chamber face, bend the float arms carefully to set the correct position.

Carburettor	Float height, mm
PHBG	16 +/- 0.5
PHBL	24 +/- 0.5
PHBH	24 +/- 0.5
PHBE	18 +/- 0.5
PHF	18 +/- 0.5
PHM	18 +/- 0.5
VHB/Z/T	24 +/- 0.5
PHSB *	11 +/- 0.5
VHSA *	11 +/- 0.5
VHSB *	11 +/- 0.5
VHSH *	11 +/- 0.5

* PHSB/VHSA/VHSB one piece float assembly

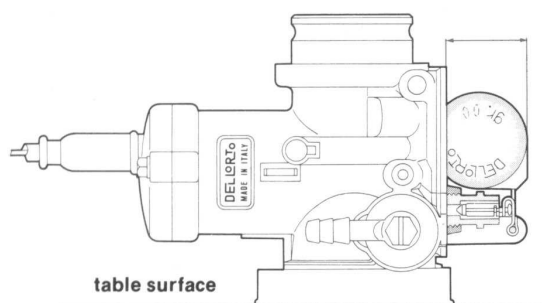

fig. 13

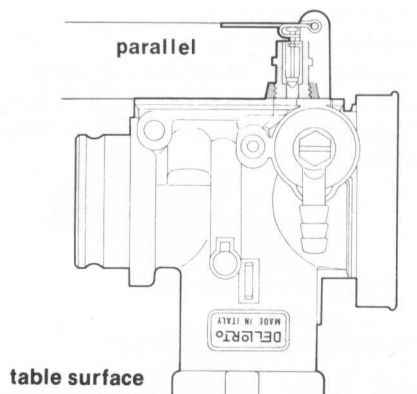

fig. 14

PHBH / PHBL / PHBE & VHST fitted with individual floats

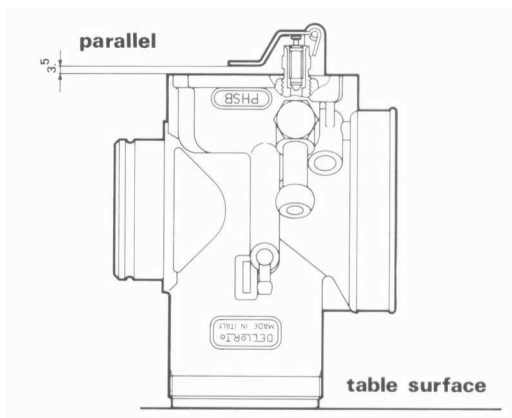

Fig 15.

PHSB / VHSA / VHSB / VHSC & VHSH fitted with individual floats